

39000 Wiring Harness

Start by removing the old wiring harness and old Regenerative Contactor (if the car has one). Then route the new harness as shown in pictures A,C,D,I,K and L. Leave the harness loose at this point and tie strap it to the frame after everything is done.

In the Dash area you will have a gang of wires, Red, Blue Orange, Brown, and one Black one. Connect the Blue wire that is marked M and N to one of the key switch terminals. The short blue wire (N) extension is only used if you have a need for some sort of 48 volt Positive accessory. On the other key switch terminal connect the red wire marked W. The extensions from that red wire connect to + Positive side of Back Up Alarm (X or Y wire) and to + Positive side of Battery Discharge Light. Connect the Brown wire (V) to the Battery Discharge Light Negative side. Connect the Orange wire (G) to Back Up Alarm negative side. Should you have need of a 48 volt negative source you can use the black wire (U) otherwise tape it up. As you route the harness along the frame (passenger side) you will notice five wires of white, blue, yellow, purple, and purple. Use picture (K) for connections. Connect the blue wire to the MCOR red wire. Connect the green wire to MCOR green wire. That is the foot switch circuit. Connect the two purple wires together marked (C). Connect the two yellow wires together marked (B). Connect the white wire marked (A) to the MCOR black wire. On some cars the black wire can be white or black with white strip. You can use different connectors if you do not have style on the 39000 harness. Any automotive store should have matching connectors.

Next is picture (J) the Forward and Reverse Switch. The three wires used are Blue, Gray and Brown. Brown wire (H) connects to the switch right hand terminal. Connect Gray wire (T) to the left hand terminal. Connect Blue wire (K) to the center terminal.

Next is picture D,E, and F. Connect red wire (F) with inline fuse (F2) to the large contactor terminal that is connected to the battery pack Positive (C Picture). Connect the blue wire marked (E/D) to one of the small Contactor terminals. Also connected to that same small terminal are blue wires K,L,J and I. If the car has a contactor with spade connections you can just cut the ends and extend a wire with a female spade connector. On the other small contactor terminal connect the black wire marked (P). Black wire (U) is a negative feed to the dash should you need to connect an accessory of some sort. Tape it up or connect it to M- on the controller.

The triangular connector in picture (H) is the Speed Sensor connection on the motor.

The 16 pin Molex connector plugs into the controller. Also shown in picture (G) a 16 pin to 24 pin connector is used for motor/controller upgrades and is not part of this kit.

Brown wire (V) connects to the computer brown wire. Note: the key switch now becomes the Run/Tow switch. You will not be using the Run/Tow but you can should you wish to. Just change the fuse wire routing to Run/Tow and add battery positive to the switch (Run/Tow).



Caution: Wear Appropriate Eye Protection!

Caution! Disconnect the battery or batteries before beginning. If the car has a run/tow switch you must place the switch into tow position first!



Copyright Nivel LLC
All Rights Reserved

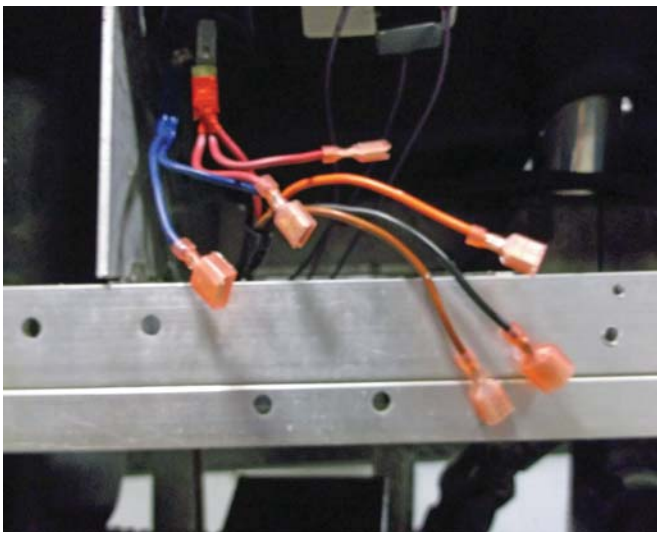

A

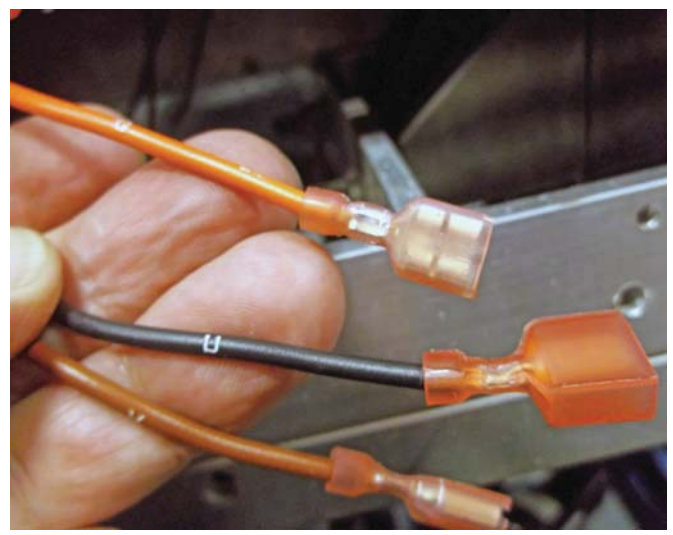

B



C

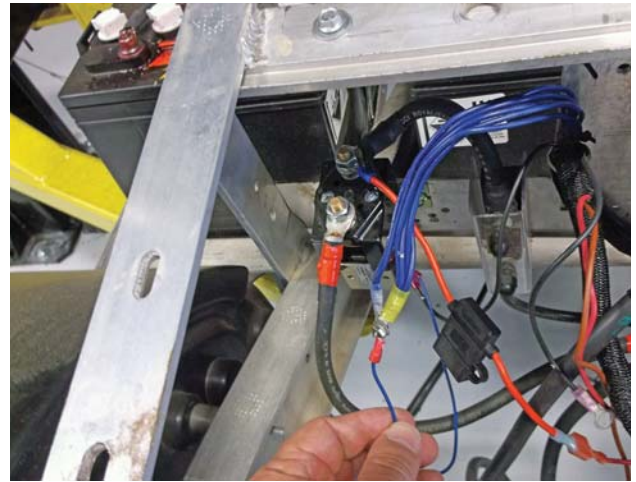

D

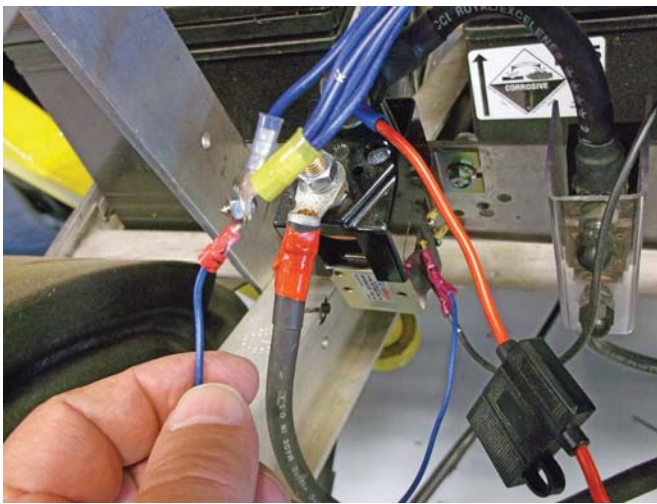

E

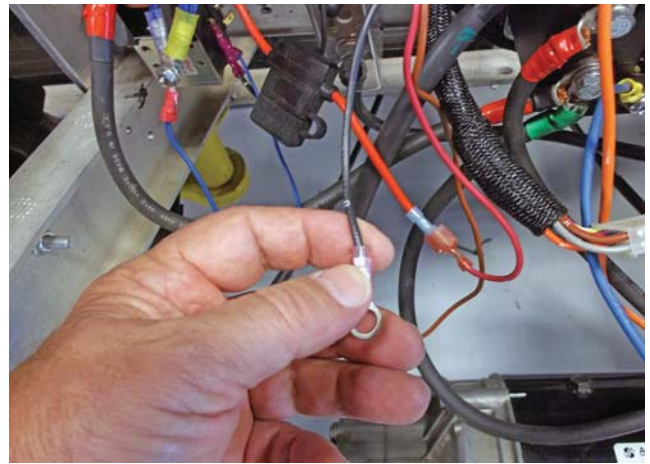

F

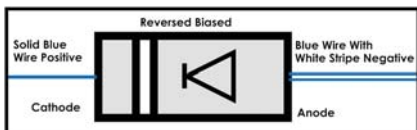

Copyright Nivel LLC
All Rights Reserved

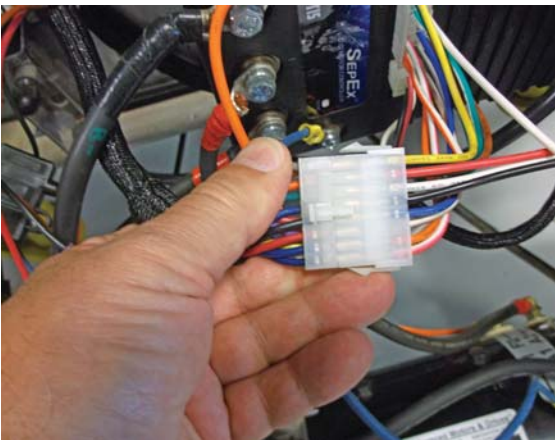

G

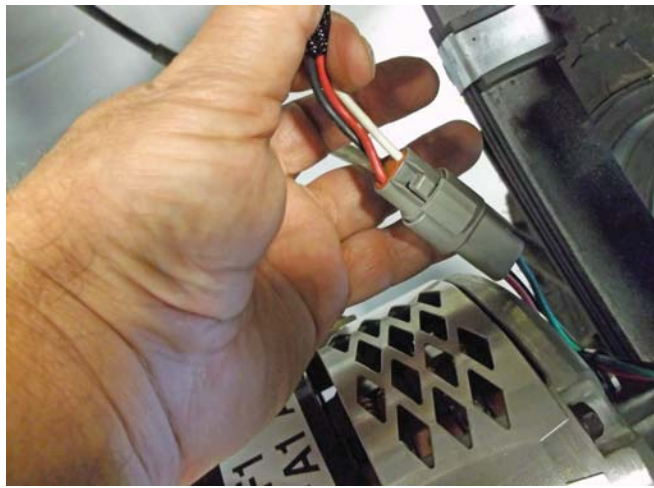

H



I

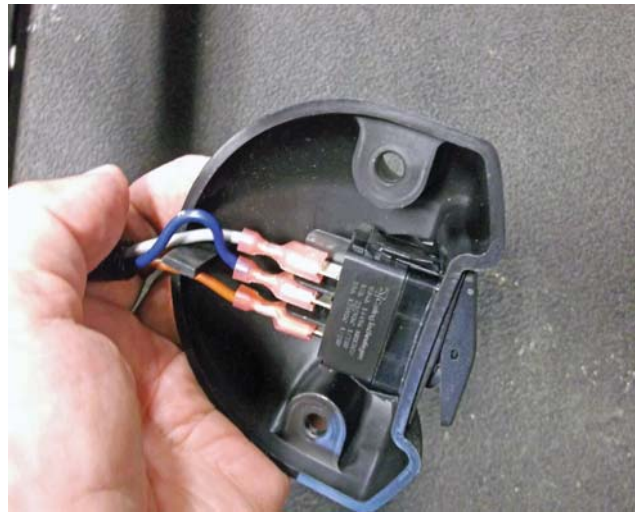

J

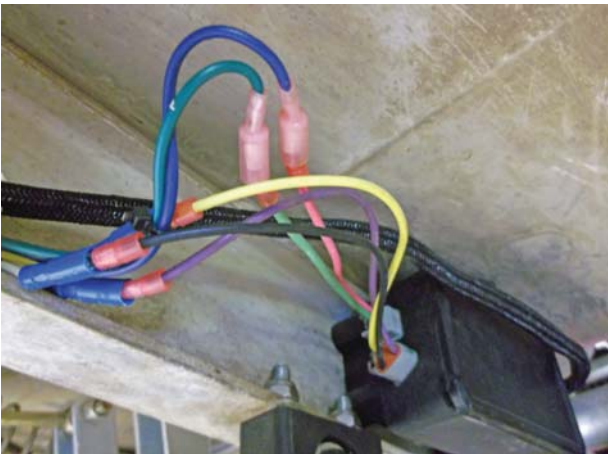

K



L

© Copyright Nivel LLC
All Rights Reserved

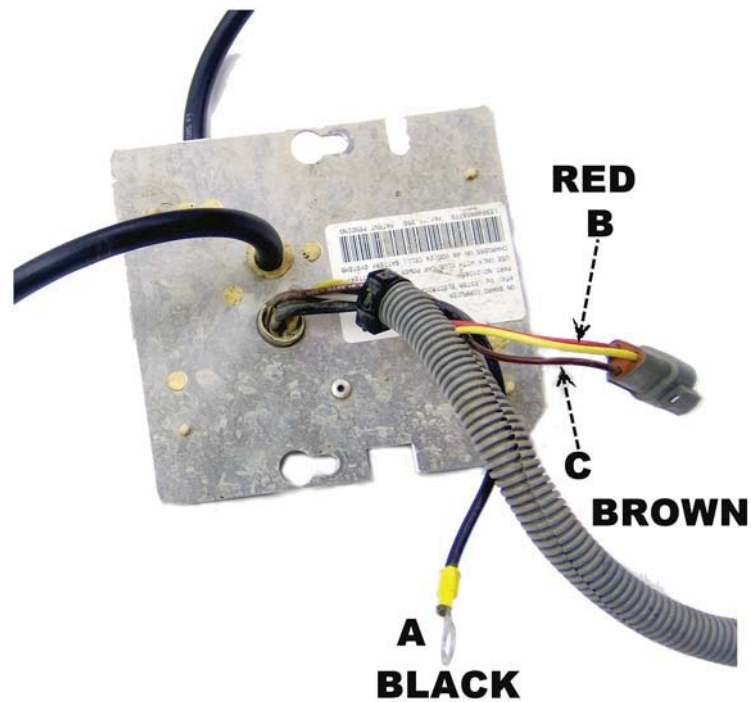

Computer Wiring:

Cut the red wire (B) and the half going into the computer connect to main battery positive. A good spot in on the main solenoid large terminal that connect directly to battery number positive.

Cut brown wire (C) and the half going to the computer connect to the new harness brown wire marked with a V on it. It also has a make 1/4" spade connector. This will operate the dash discharge indicator and is a negative pulse.

The yellow wire do nothing with it just tape it up.

The large 12 gauge wire (A) connect to B- on the controller. That is a main battery negative. That is the same terminal the large negative cable fro the battery pack is connected.

Indemnification And Insurance Agreement

High Performance Enhancement Kit purchaser assumes sole and entire responsibility for, and shall indemnify and save harmless Nivel LLC, from any and all claim, liability, responsibility, and persons or property that may be sustained in connection with the use of any product before or after purchase, including but not limited to high performance enhancement motors. The High Performance Enhancement Kit purchaser also shall indemnify Nivel LLC harmless with respect to any and all liability that may be incurred.

Golf Cars are recommended for use only by those aged 16 and older. Golf cars can be especially hazardous to operate. Always remember that riding and alcohol/drugs don't mix. Never ride on public roads. Never carry more that two passengers (except shuttles and trams). Never engage in stunt driving. Avoid excessive speeds and be particularly careful on difficult terrain. Nivel LLC reserves the right, at any time, to discontinue or change specifications, prices, designs, features, models, or equipment without notice and without incurring any obligation.



**Copyright Nivel LLC
All Rights Reserved**

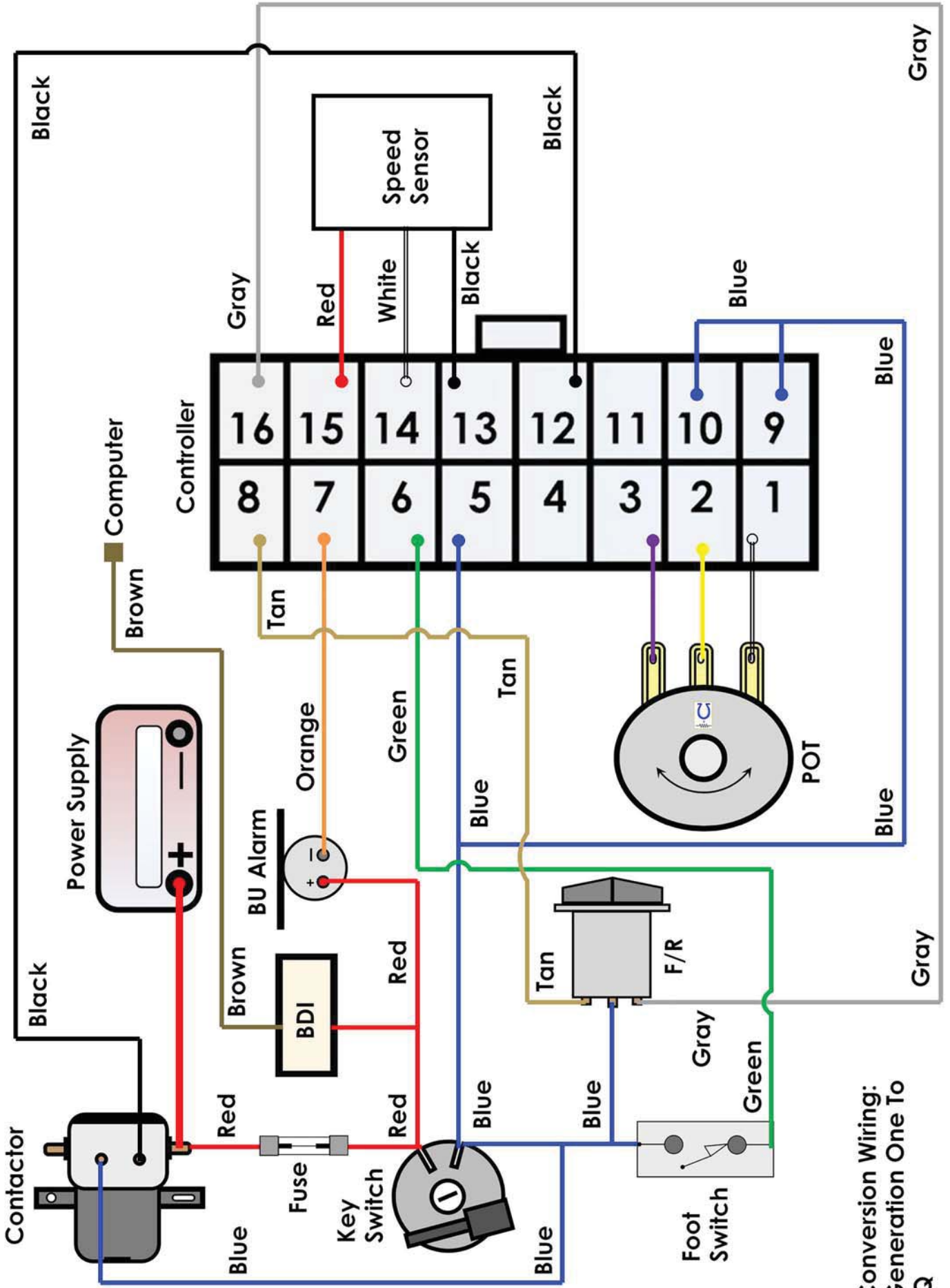

Conversion Wiring:
Generation One To
IQ